

"MatchBox" by runoffgroove.com

PCB layout by Pablo De Luca (aka Gringo)
Version 1.4 October 22, 2004

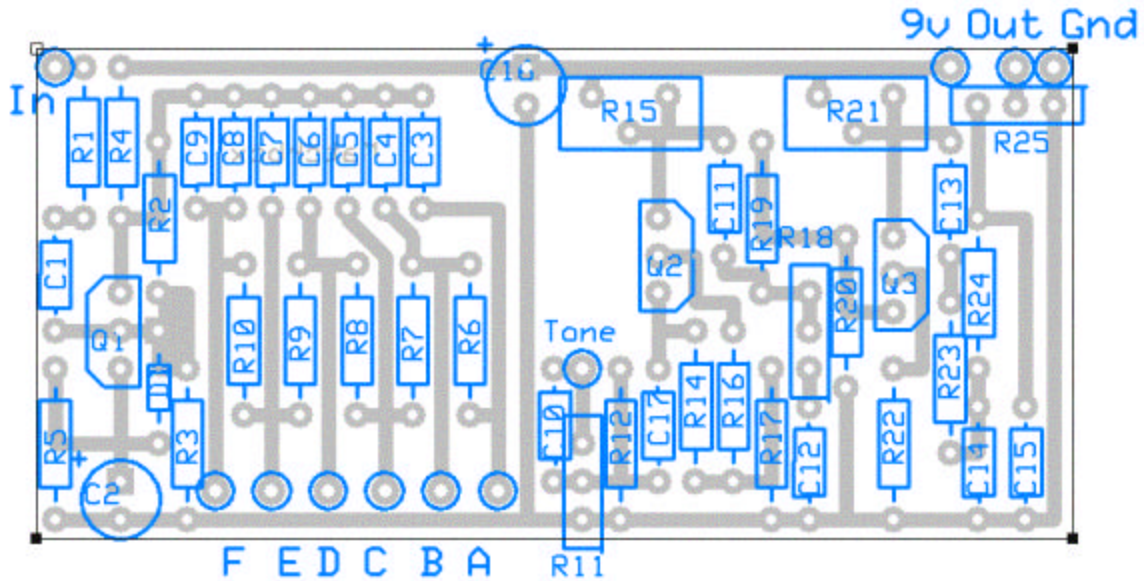

Parts List:

Capacitors	Resistors	Semiconductors	Misc
C1 10n	R1 33k	Q1 BS170	SW1 (1P6T) Tone
C2 22uF	R2 1M	Q2 J201	
C3 360p	R3 1M	Q3 J201	
C4 560p	R4 15k	D1 Red Led	
C5 1n2	R5 1k2		
C6 2n2	R6 5M1		
C7 4n7	R7 5M1		
C8 10n	R8 5M1		
C9 180p	R9 5M1		
C10 180p	R10 5M1		
C11 47n	R11 1M A Vol		
C12 10n	R12 470k		
C13 10n	R14 1M		
C14 2n2	R15 100k trim		
C15 2n2	R16 1k2		
C16 100uF	R17 4k7		
C17 10n	R18 250k		
	R19 1k5		
	R20 220k		
	R21 100k trim		
	R22 62		
	R23 15k		
	R24 15k		
	R25 100k A Master		

Transfers:

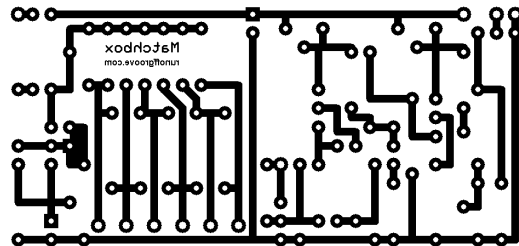
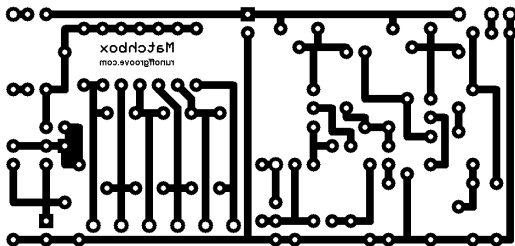
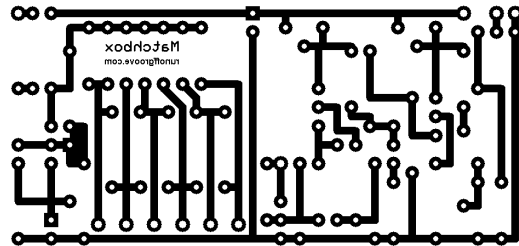
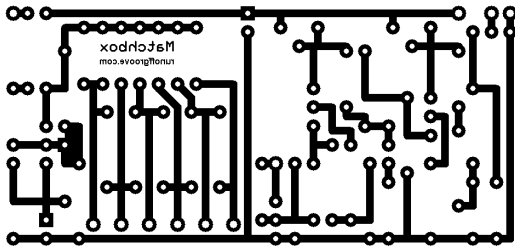
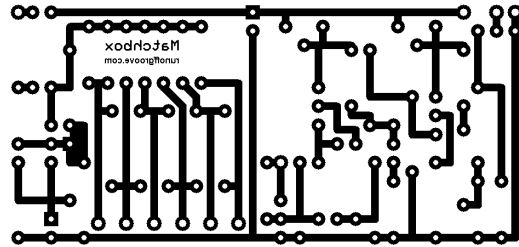
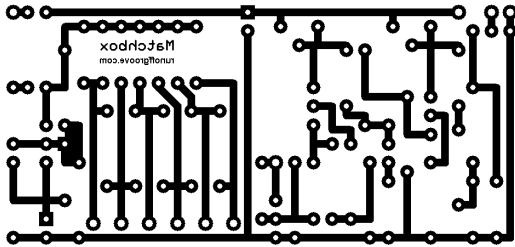

Board dimensions : 69.8mm x 33mm (2.75" x 1.3")